

Overtopping Failure

Best Practices in Dam and Levee Safety Risk Analysis
Part D – Embankments and Foundations
Chapter D-3

Last modified June 2017, presented July 2019



US Army Corps
of Engineers®



Objectives

- Understand the mechanisms that affect overtopping and wave overwash
- Understand how to construct an event tree to represent overtopping
- Understand how to estimate the probability of breach or focus on overtopping failure probabilities with fragility curves

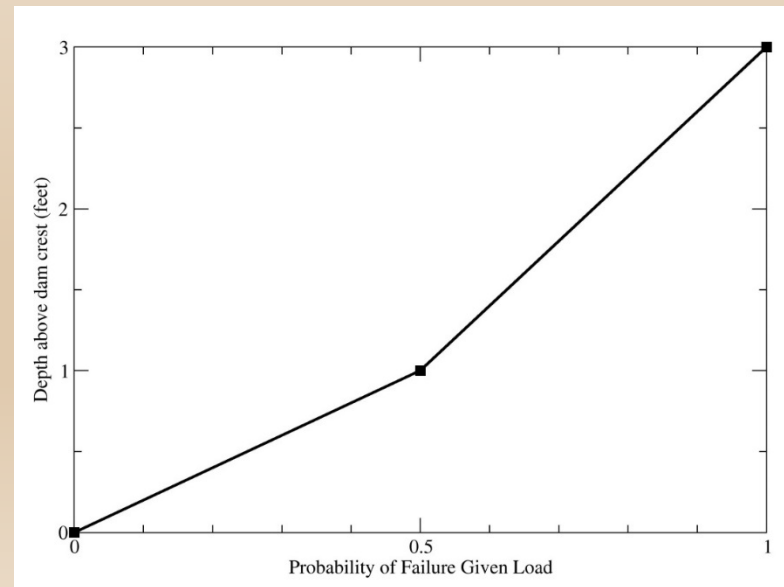

Dam and Levee Overtopping Failure Mode

- Failure of dams and levees due to overtopping is a common failure mode
 - 30% of dam failures in U.S. are attributed to overtopping
- Embankments overtopped by a few inches to a foot or more have performed well but others have failed quickly
- Many older dams and levees may have been designed for floods that no longer represent a remote flood event and design flood estimates have increased



Lake Delhi Dam Failure



Lake Delhi Dam, Eastern Iowa July 24, 2010
Overtopping and Internal Erosion Failure
(43 foot high embankment, 3,790 acre-ft)



Auburn Cofferdam Failure



Middle Fork,
American River, CA
265 feet high
February 18, 1986



Taum Sauk Upper Dam



East Fork Black River, MO
Pump storage dam
94 feet high
December 14, 2005



Rainbow Lake Dam Failure



Pine Creek, central Michigan
September 10-11, 1986

One of 14 dam failures during this event from flood overtopping and seepage



Laurel Run Dam Failure



Johnstown, PA - 42 foot high embankment
Flood Overtopping Failure, July 20, 1977
40 deaths



Gibson Dam, MT Overtopping Case

- Concrete arch dam 199 ft high
- June 6-8, 1964 record regional rainstorm in northern Montana (PMP defining event – HMRs 55A and 57) on heavy snowpack
- Spillway radial gates not fully open – lead to overtopping
 - controls inaccessible
 - 2 gates completely open
 - 2 gates completely closed
 - 2 gates partially open
- Overtopping about 3 feet over parapet for 20 hours but did not fail
- Modified in 1981 to allow overtopping by up to 12 ft – abutment protection and anchors

From ICOLD Bulletin 82 (1992) and Reclamation files



Gibson Dam Overtopping June 8, 1964



Gibson Dam Modification



Hurricane Katrina - New Orleans, LA August 2005 Levee and Floodwall Breach



South I-wall breach along the east side of the IHNC

Catastrophically eroded levee section along the northeast frontage of the St Bernard Parish levee, MRGO channel



Hurricane Katrina - New Orleans, LA August 2005 Levee and Floodwall Breach

**NOT ALL EMBANKMENTS FAIL
WHEN OVERTOPPED!**



Levee on south alignment of New Orleans East at the Paris Road Bridge. Clay levee was overtopped but did not breach



Levee section on the east edge of the New Orleans East protected basin showing a complete lack of erosional damage



Dam and Levee Overtopping

Two ways for the dam or levee to overtop:

- Overwash occurs when the water surface is below the crest elevation of the structure and wind driven waves wash across the crest of the structure
 - Wind setup and wave run-up contribute to the likelihood of overwash occurring
- Continuous overtopping occurs when water depth exceeds crest of an embankment resulting in continuous flow over the structure
 - This can be from the combination of the still water level (SWL) and wind setup

Breach can occur from either or a combination of both though breach from overwash alone would likely require a long duration

Should be Considered in the Same Failure Mode!



Dam and Levee Overtopping

Overtopping occurs from the combination of the still water level (SWL) and wind setup exceeding the crest of the dam. For overwash, wind setup and wave run-up intermittently combine to produce a water level exceeding the crest of the dam. Typically a significant surface area upstream (fetch) is required to allow wind to develop waves that would be directed towards the embankment and overtop it.

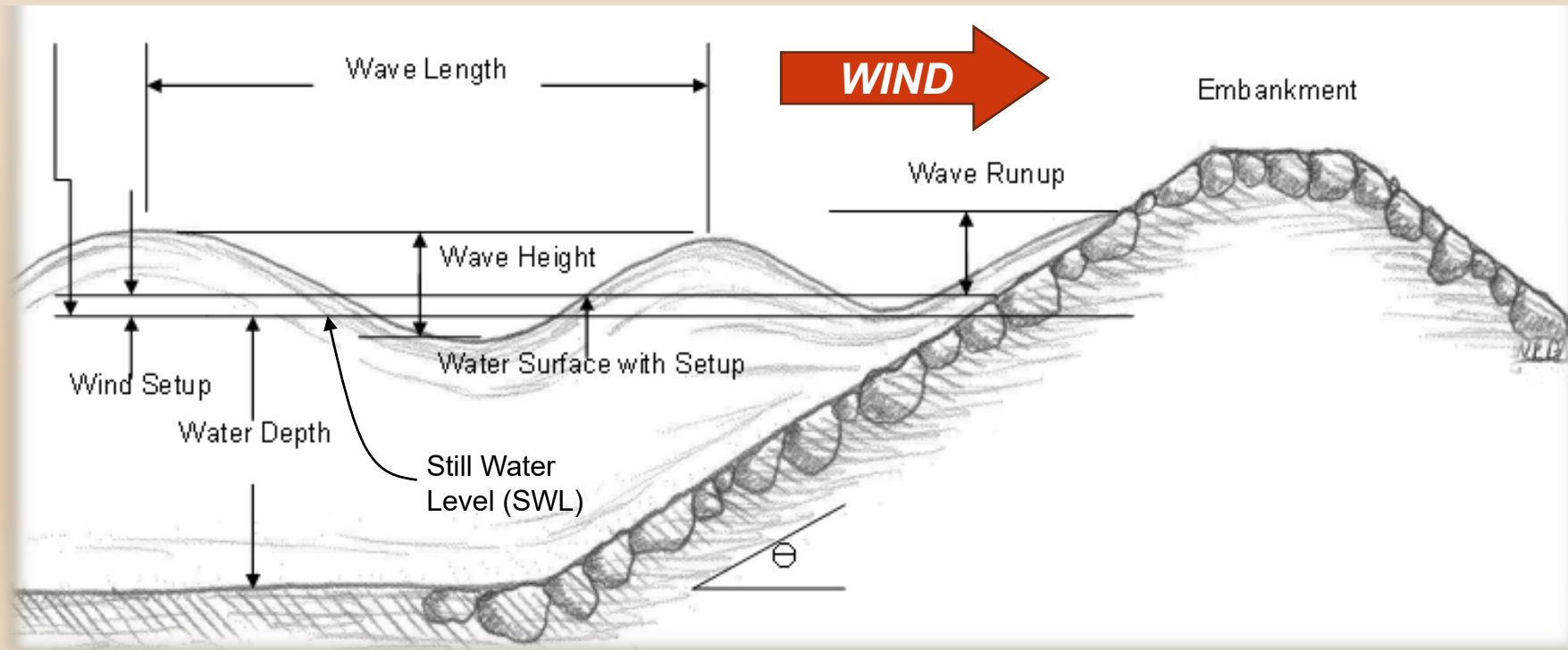

Embankments and Concrete Structures

Depth of Overtopping

- Most embankment dams and levees would likely not withstand sustained overtopping of a foot to two feet or more without a high probability of failure
- Most concrete dams can likely withstand a certain level of overtopping due to the robust nature of the structure itself and the rock foundation; some may be vulnerable due to jointing and fracturing in the rock foundation



Embankment Overtopping Failure

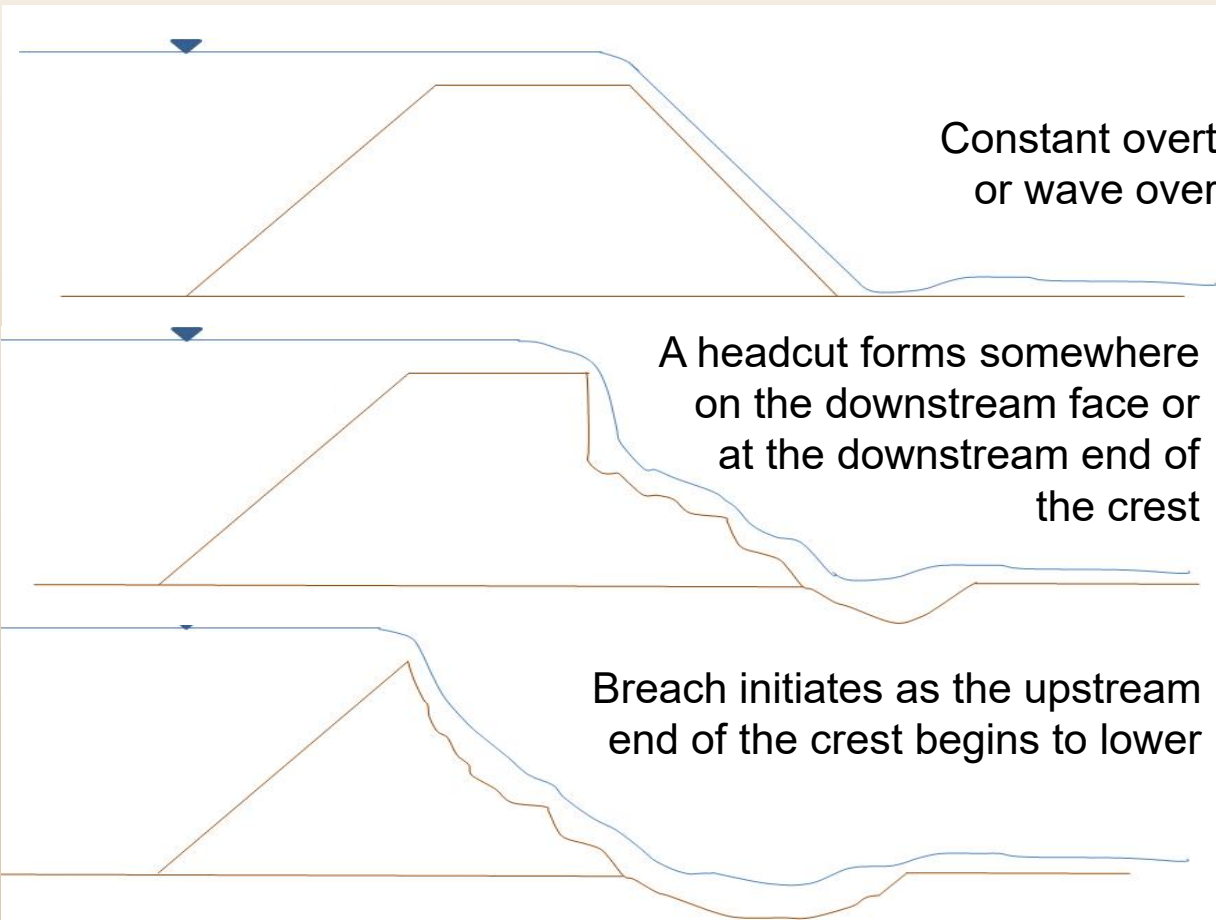

COHESIVE MATERIALS

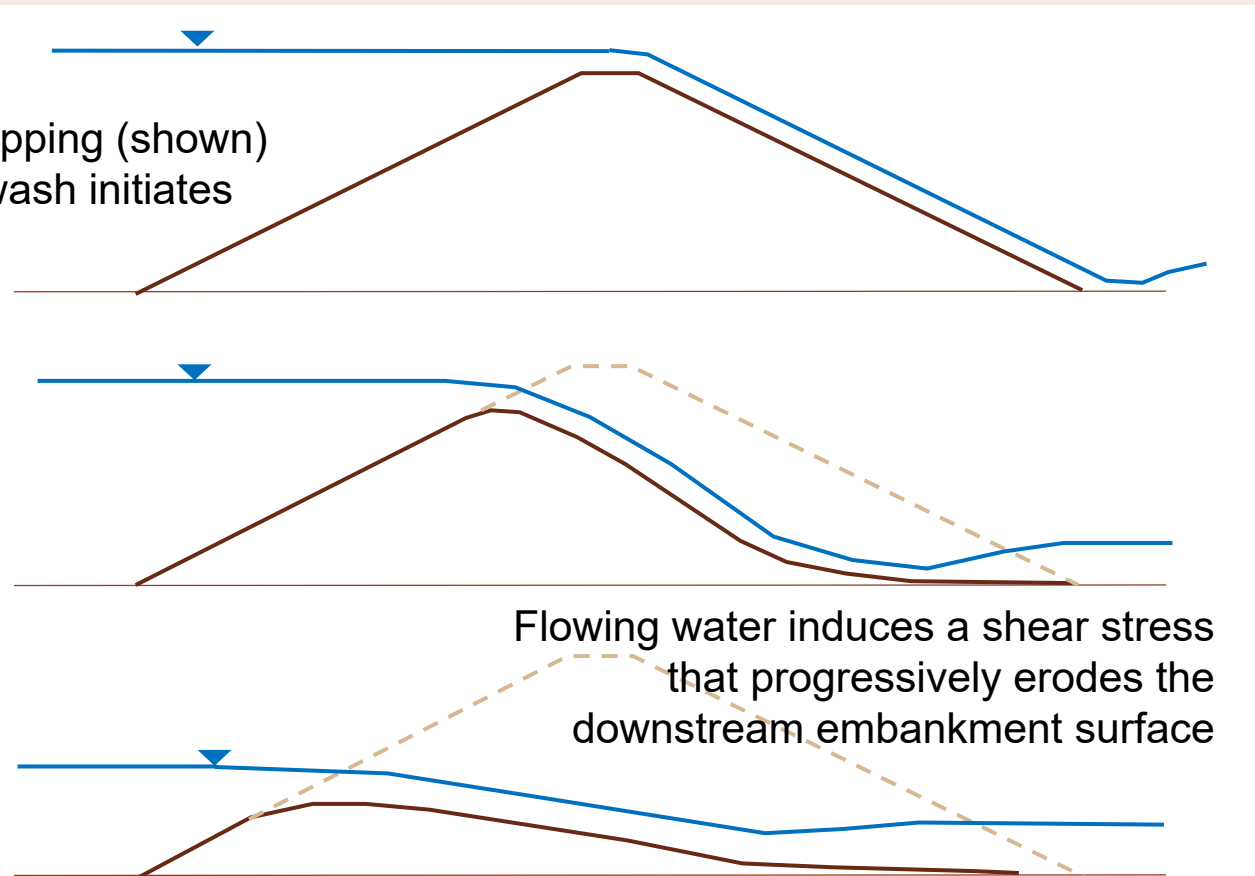

COHESIONLESS MATERIALS



Key Embankment Erosion Processes

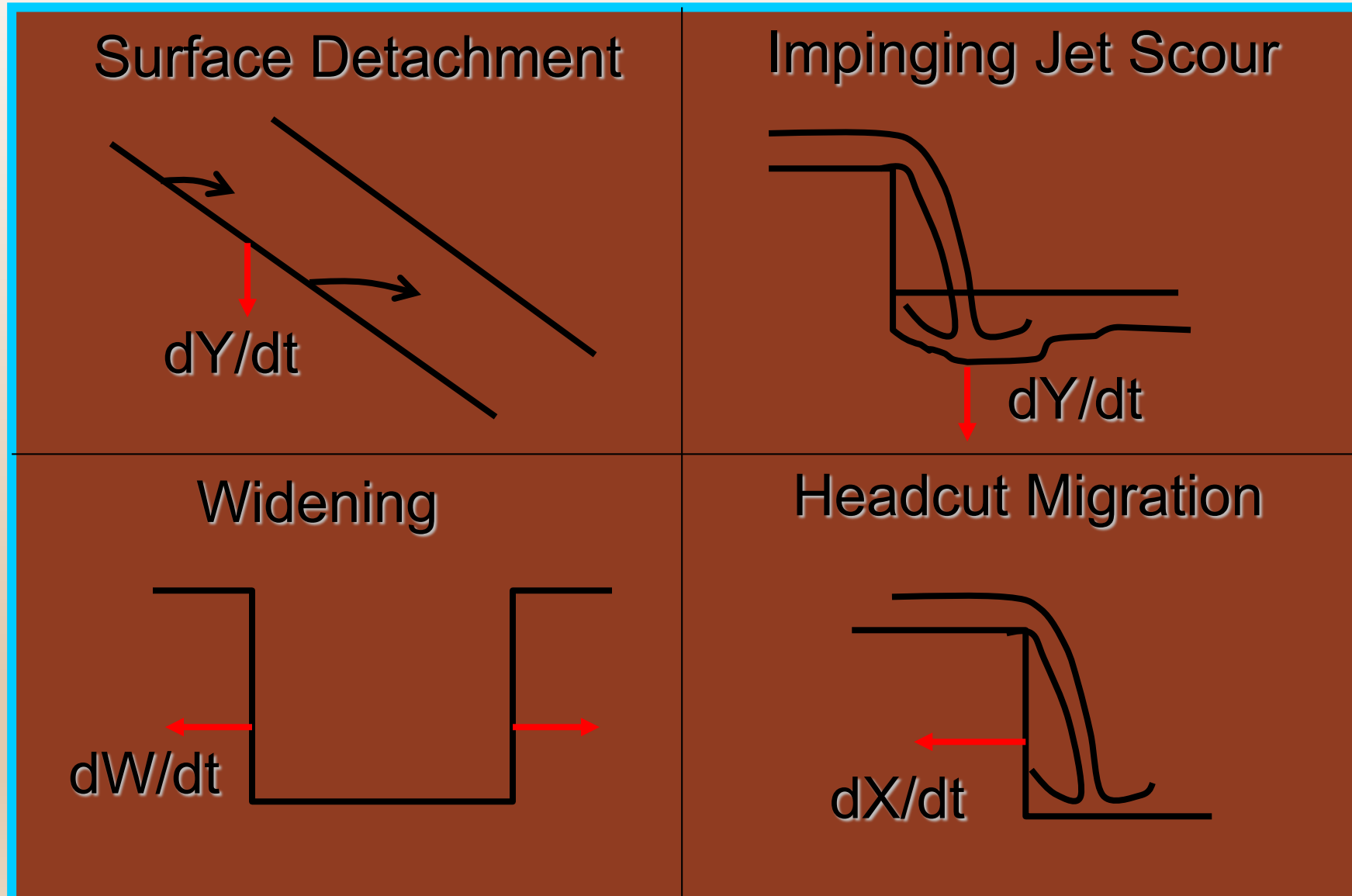

Courtesy of USDS-ARS: WinDAM Training materials



Headcut Process



Courtesy of USDS-ARS: WinDAM Training materials



Crest Elevations - Overtopping

- Embankment crest elevations change over time and may vary longitudinally
 - Consolidation settlement of the embankment or foundation
 - Regional subsidence due to mineral extraction or groundwater withdrawal
- Surveys of embankment (levee or dam) crest are recommended to determine the crest elevation and to identify low spots
 - Helps to identify where overtopping is likely to occur first
 - May identify where flow concentrations may occur
- Crest can be lowered by other failure modes
 - Seismic deformation, internal erosion, etc.



Dam and Levee Overtopping

- Levee overtopping is likely to occur at a (much) greater frequency than dams due to differences in design criteria
- Additional factors can increase water surface elevations:
 - Debris blockage
 - System operations changes and tributary inflows
 - Original modeling technique
 - Change in understanding of the potential inflow (revised PMF) or a change in the estimated frequency (overtopping may be more likely to happen)
 - Crest settlement may increase likelihood for overtopping
 - Addition from bridges or other encroachments (typically levees)
 - Channel roughness changes (typically levees)



Embankment Overtopping: Factors Influencing Likelihood of Failure

- Depth and duration of overtopping
- Camber or low spots on dam or levee crest may concentrate overtopping flows
- Downstream materials, slope protection, changes in slope/protrusions
- Embankment crest materials, protection
- Wind set-up, wave run-up, and the fetch necessary to develop it
- May initially assume that any overtopping depth may initiate erosion progression to breach for a lower-order study
- Fragility curves/system response curves should be developed based on site characteristics and structure
- Lack of splash pad or surface protection behind floodwalls, particularly I-walls, will make the materials directly behind wall vulnerable to overtopping
- Transitions from one type of flood protection to another have performed poorly in the past
- Mechanical/electrical controls for outlets still operational?



Concrete Dam Overtopping: Factors Influencing Likelihood of Failure

- Depth and duration of overtopping
- Foundation conditions
 - Joint/fracture/bedding orientation and spacing
 - Erosion resistance/durability
- Tailwater elevations
- Mechanical/electrical controls still operational?



Embankment Overtopping Events

- A flood occurs that causes the river/reservoir level to rise above the crest of the embankment and overtopping initiates
- After overtopping has initiated, vegetation and/or slope protection is removed upon reaching its critical shear stress
- Erosion of the embankment is (1) initiated along the downstream slope of a cohesionless embankment or (2) at the downstream end of the crest or a change in slope of a cohesive embankment and a headcut forms
- (1) Particle transport or (2) headcut advances to the upstream end of the crest (and can deepen and widen at the same time)
- The embankment crest is lowered and (eventually) breach occurs



Embankment Overtopping Event Tree (Reclamation)

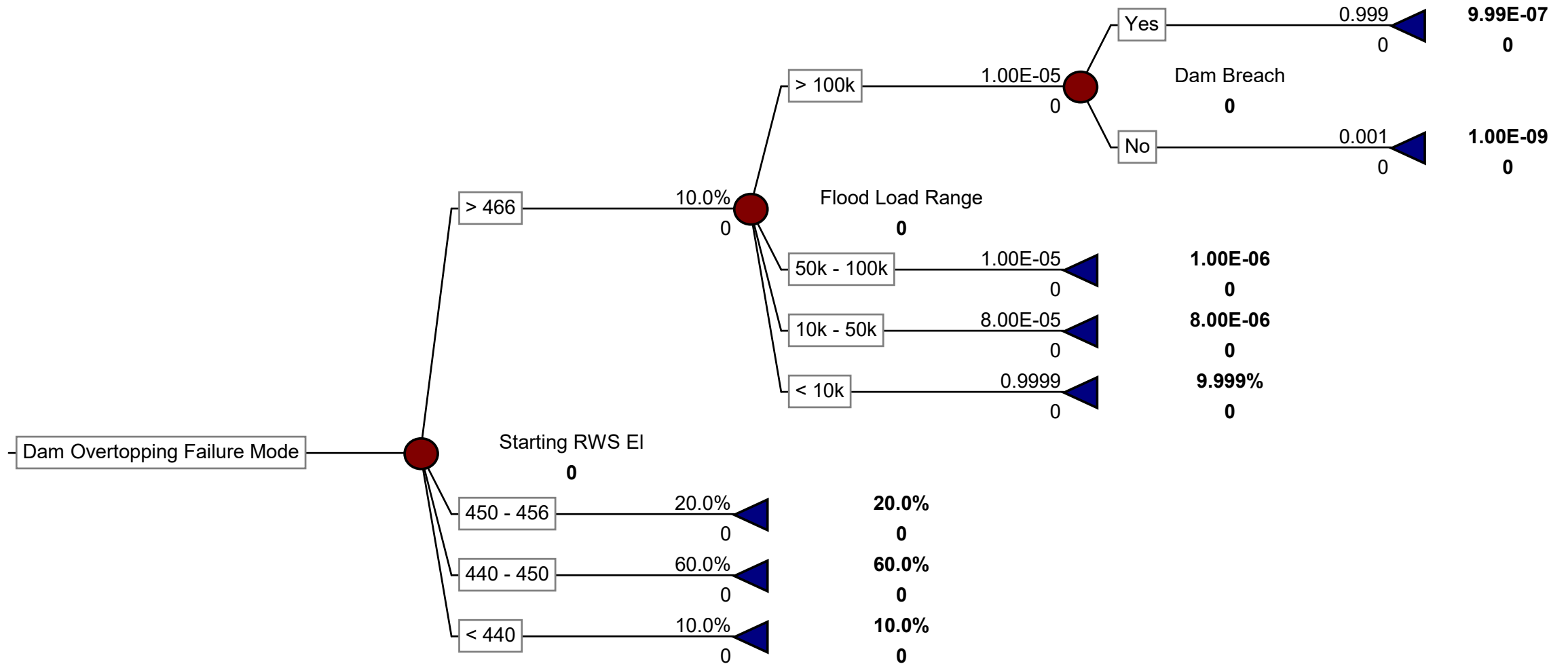

Conditional failure probabilities often simplified



Embankment Overtopping Event Tree (USACE)

- Flood Load Range
- Overtopping/overwash leads to initiation of headcutting erosion
- Headcutting advances to upstream end of crest
- Dam breaches



Conditional failure probabilities often simplified



Concrete Dam Overtopping Event Tree

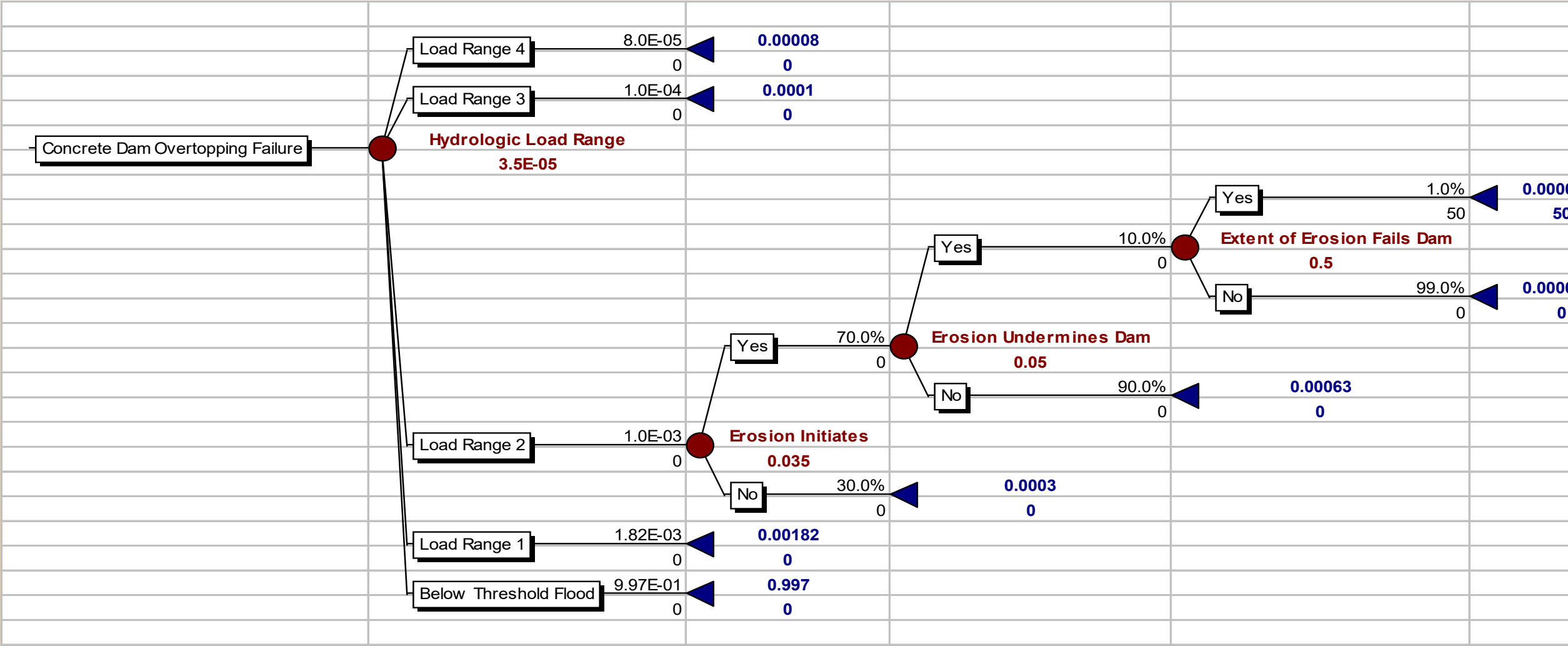

Risk Estimates for Dam Overtopping

- Reservoir stage-frequency analysis with uncertainty (Chapter B-1 Hydrologic Hazard)
- Discretize loadings to key elevations
- Estimate load probabilities for reservoir elevation ranges based on stage-frequency curve
 - Resolve these load ranges into overtopping depths
- Estimate conditional failure probabilities (likelihood of breach) for each overtopping depth range
 - How? It depends on the level of study



Predicting Embankment Overtopping Breach and Breach Parameters

- ***Refer to Chapter C-1 (Breach Development)***
- **SCREENING LEVEL:** Estimate if breach occurs based on familiarity with existing case histories, personal experience (low level of effort)
 - Assume the embankment fails either at incipient overtopping (cohesionless embankment) or within approximately 1 ft of overtopping (clay embankment) with any significant duration (2 to 4 hours or more)
 - Use an embankment's characteristics to estimate behavior based on similar dams Prediction equations (empirical methods)
 - Xu and Zhang
 - Froehlich
 - Von Thun
- **INTERMEDIATE:** Customize existing H&H analyses to estimate breach parameters (HEC-RAS 5.0)
 - User-entered inputs (empirical equations and other parameters)
 - Simplified physical breach method (velocity-breach time relations)



Predicting Embankment Overtopping Breach and Breach Parameters

- RIGOROUS: Physically based breach models to estimate breach erosion rates, width, expected formation, and time to breach (to estimate if breach occurs and breach parameters, rigorous)
 - WinDAM: Calibrated for cohesive, homogenous embankments and headcut migration
 - Includes vegetation and material type factors (
 - NWS Breach: Cohesionless, homogeneous embankments and sediment transport
 - HR Breach/EMBREA: heterogeneous embankments, both erosion mechanisms

BEST PRACTICE: Combining results from several equations/ assumptions and conducting sensitivity analyses is warranted for higher order risk assessments. Run analyses to define the limit state (how much overtopping to fail?) to inform judgement. Vary initiating hydrologic event and soil inputs to estimate how the breach dimensions and likelihood of breach development changes. It's possible to incorporate Monte Carlo analysis on a distribution of most likely values (Excel/ @Risk) to estimate APF/Consequences/ALL.



Summary of Risk Estimates for Dam Overtopping/Overwash

Based on Reservoir Pool Frequency Curve – Flood Routings

Reservoir Water Surface El Range, ft	Corresponding Frequency Flood from Flood Routings	Spillway Discharge Capacity, ft ³ /s	NODAL ESTIMATE: Probability of Pool Occurring	Freeboard (+) Overtopping (-) Depth, ft	NODAL ESTIMATE: Estimated Probability of Failure	RESULT: Annual Probability of Failure	RESULT: Annualized Loss of Life ¹
740 – 749	200-50,000	0 – 7400	.00498	9 to 2	0	0	0
749 – 750	50,000-300,000	7400 – 8670	.0000167	2 to 1	0 to 0.1	8 E-07	8 E-05
750 – 751	300,000-700,000	8670 – 10,000	.0000019	1 to 0	0.1 to 0.3	4 E-07	4 E-05
751 – 752	700,000-900,000	10,000 – 11,390	.00000032	0 to -1	0.3 to 0.999	2 E-07	2 E-05
752 – 753	> 900,000	11,390 – 12,848	.0000011	> -1	1	1 E-06	1 E-04
Totals						2.4 E-06	2.4 E-04

¹ Loss of life of 100 people estimated for all cases.



Uncertainty

Flood Routings for Embankments

- Flood Events
- Starting Reservoir Water Surface Elevation
- Reservoir Operations/Misoperations
- Spillway Discharge
- Modifications to the spillway approach

Hydrologic Hazard

- The size and shape of flood hydrographs may vary, depending on the peak and volume considerations and variations and the type of flood (thunderstorm or rain-on-snow flood)
- Hydrologic hazard assessments may have been based on short records or anchoring to design floods
- Large uncertainties in flood hazard due to lack of data or reliance on older analyses
- The peak and volume of a flood with the same return period as the original inflow design may have changed over time



Uncertainty

Initial/Antecedent Reservoir Water Surface Elevation

- The starting reservoir water surface elevation can be a critical input for flood routings
- The default elevation may be the top of active conservation storage, top of flood control or normal pool, but historical reservoir level data may indicate the reservoir is at this level a small percentage of the time
- If starting reservoir water surface elevation is significant, flood routings should consider this variable and results incorporated into the event trees
- Consideration for starting reservoir water surface elevations should also include the time of the year the flood is likely to occur

Reservoir Operations/ Misoperations

- The assumptions regarding reservoir operations for flood routings should be evaluated for reasonableness
- If gated spillway operations will exceed downstream safe channel capacity, operators may be reluctant to follow SOP (Reclamation) or Water Control Manual (USACE)
- Gated spillways may be vulnerable to one or more gates failing during a flood, due to mechanical failures, loss of power or gate binding
- Sensitivity routings can evaluate variable assumptions



Uncertainty

Spillway Discharge

- Spillway discharge curves used in flood routings are often based on idealized discharge curves.
- Approach conditions that are less than ideal may reduce the discharge from what was assumed.
- Debris may block spillway openings and significantly lower the discharge.
- For gated spillways, flow will vary at a given water surface elevation depending on whether free flow or orifice conditions exists.

Embankment Performance During Overtopping

- Need to be careful when considering overtopping load partitions: when does embankment performance during overtopping change? At 0.5 ft of overtopping? 1, 2, 4 ft? All of these? We need to account for this change in behavior in the event tree.
- Overtopping duration is a key parameter
- Surface protection: grass, rip-rap, bare soil. Additional event in the tree.



Uncertainty

Embankment Performance During Overtopping

- Embankment zonation: clay core with rock shells? How does this affect performance?
- Breaks in downstream slope
- Erosion mechanism: headcutting (cohesive soils) or surface erosion (cohesionless soils)
- Debris in overtopping flows (trees, etc): can concentrate flows and accelerate erosion
- Crest paving: beneficial for surface erosion but not for headcutting

Soil Erosion Model Parameters

- Erodibility Coefficient, k_d !!!
- Breach models are extremely sensitive to k_d and potentially critical shear stress
- k_d is hard to estimate; good data out there for clays, less for sands, virtually none for gravels
- Models live in a simple continuum uncomplicated by reality. Use only to inform your judgement; this makes sensitivity analysis your most valuable tool



Conclusions

- Overtopping flow and wave overwash could be potential failure modes for both dams and levees
- The specific erosion mechanism depends on the material the embankment is composed of: cohesive/cohesionless, headcutting/sediment transport. A combination of both can occur
- Depth and duration of overtopping are key factors
- Erodibility of earthen embankments material is key factor
- Erodibility of the rock foundation is a key factor for concrete dams

